

# Special tools

**TOP33-60°**

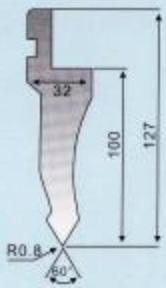

**TOP34**

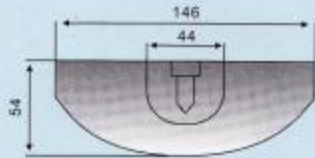

**TOP35**

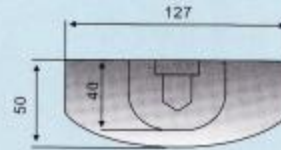

**TOP36**

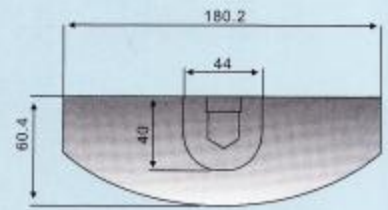

**WA10-88°-86°-30°**

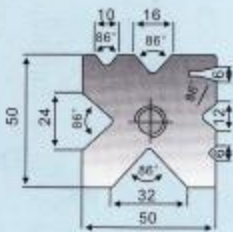

**WA20-88°-86°-30°**

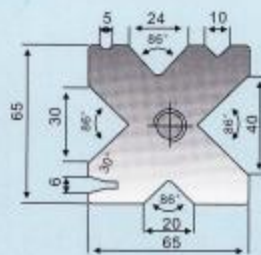

**WA30-88°-86°-30°**

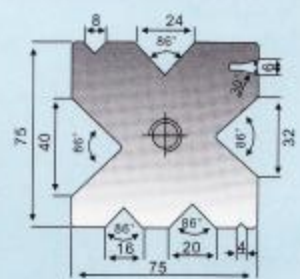

**WA40-88°-86°-30°**

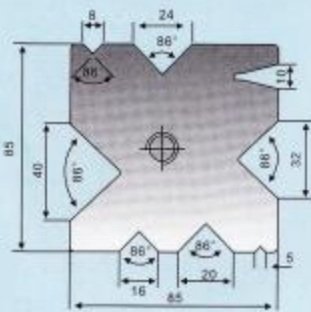

**WA50-88°-86°**

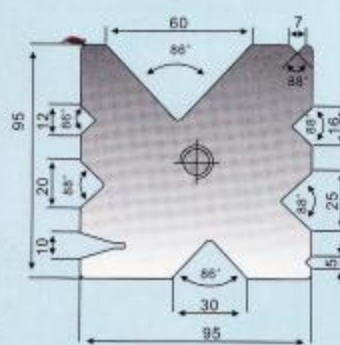

**WA60-86°**

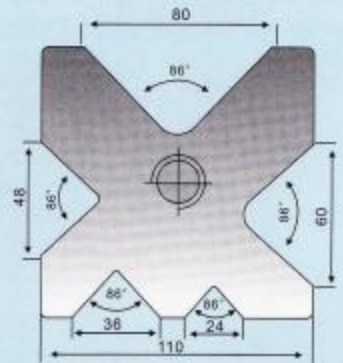

**TOP 601-88°-30°**

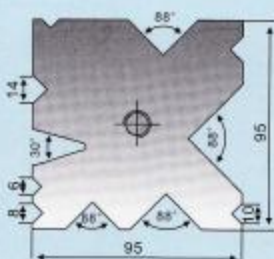

**TOP 602-88°-30°**

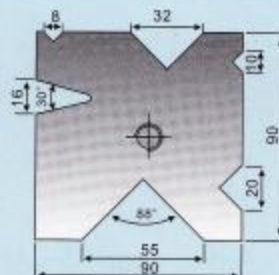

**TOP 603-88°-30°**

