

Special tools

TOP33-60°

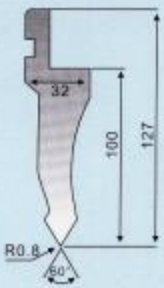

TOP34

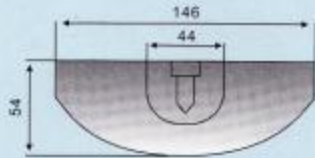

TOP35

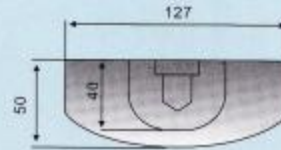

TOP36

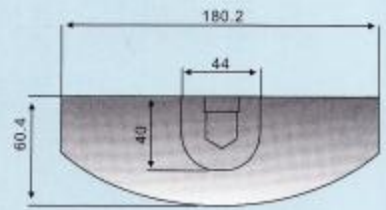

WA10-88°-86°-30°

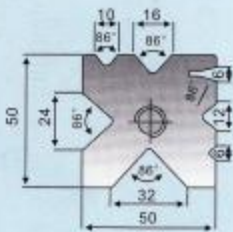

WA20-88°-86°-30°

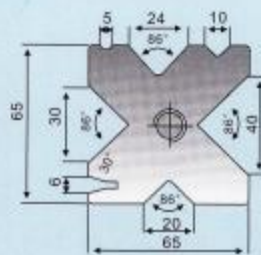

WA30-88°-86°-30°

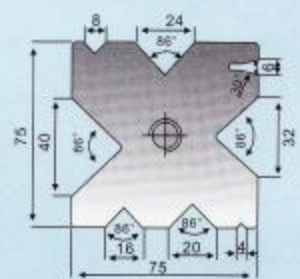

WA40-88°-86°-30°

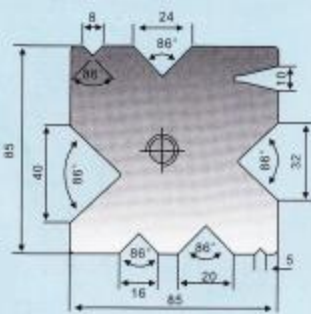

WA50-88°-86°

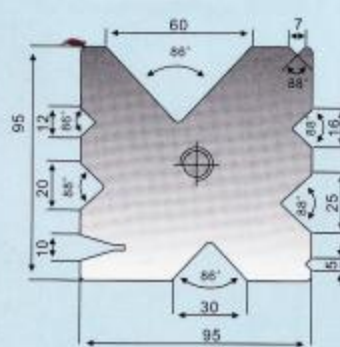

WA60-86°

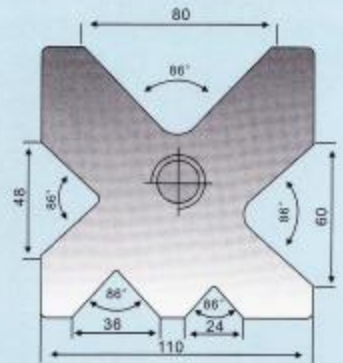

TOP 601-88°-30°

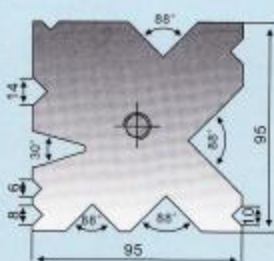

TOP 602-88°-30°

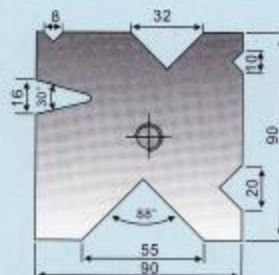

TOP 603-88°-30°

